

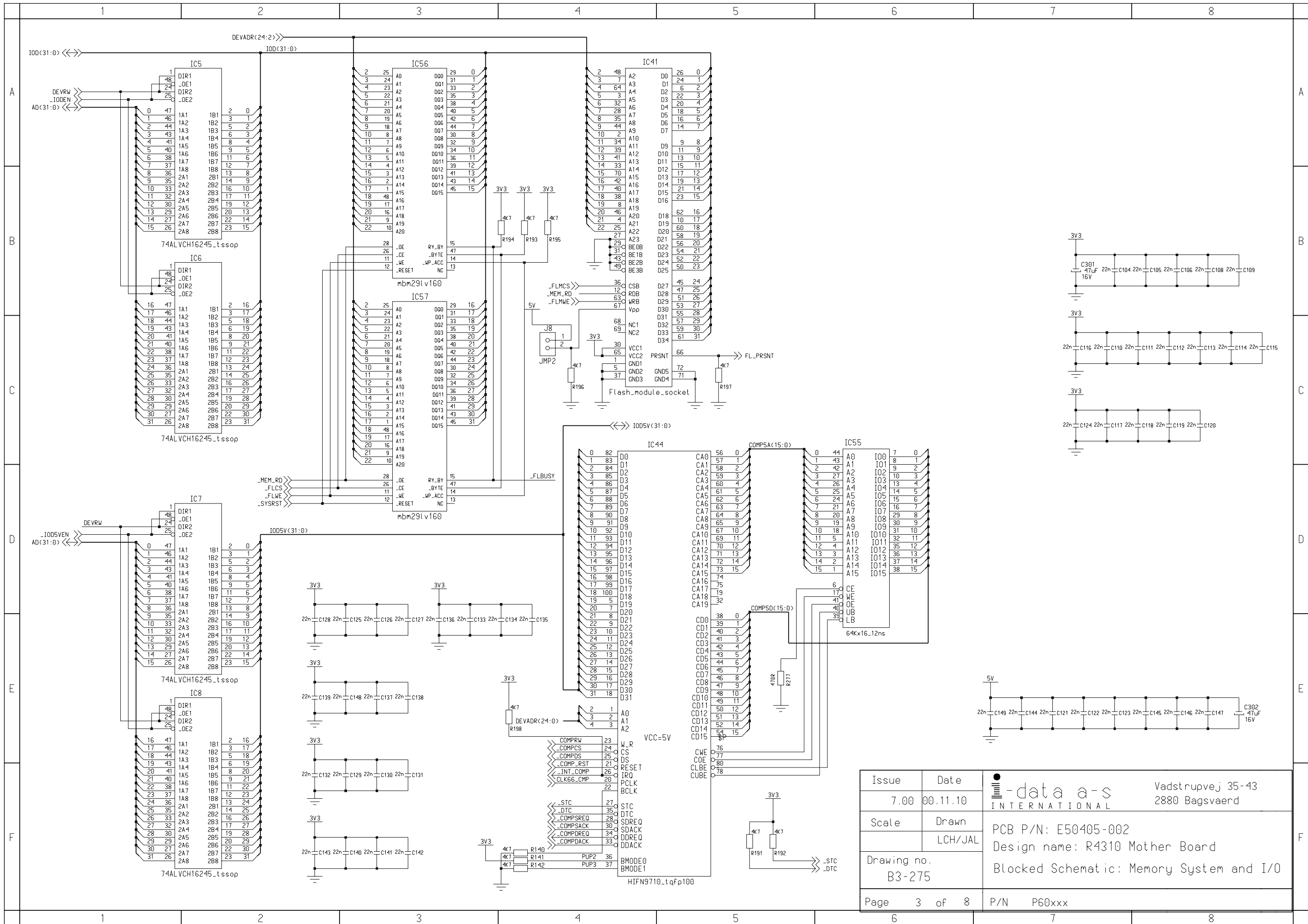

Issue	Date	-data a-s INTERNATIONAL	Vadstrupvej 35-43 2880 Bagsvaerd
7.00	00.11.10		
Scale	Drawn	PCB P/N: E50405-002	
	LCH/JAL	Design name: R4310 Mother Board	
Drawing no.	B3-275	SDRAM CIRCUIT	
Page	2 of 8	P/N	P60xxx



Issue	Date	 Vadstrupvej 35-43 2880 Bagsvaerd
7.00	00.11.10	
Scale	Drawn	PCB P/N: E50405-002 Design name: R4310 Mother Board Blocked Schematic: Memory System and I/O
	LCH/JAL	
Drawing no.	P/N P60xxx	
B3-275		
Page	3 of 8	

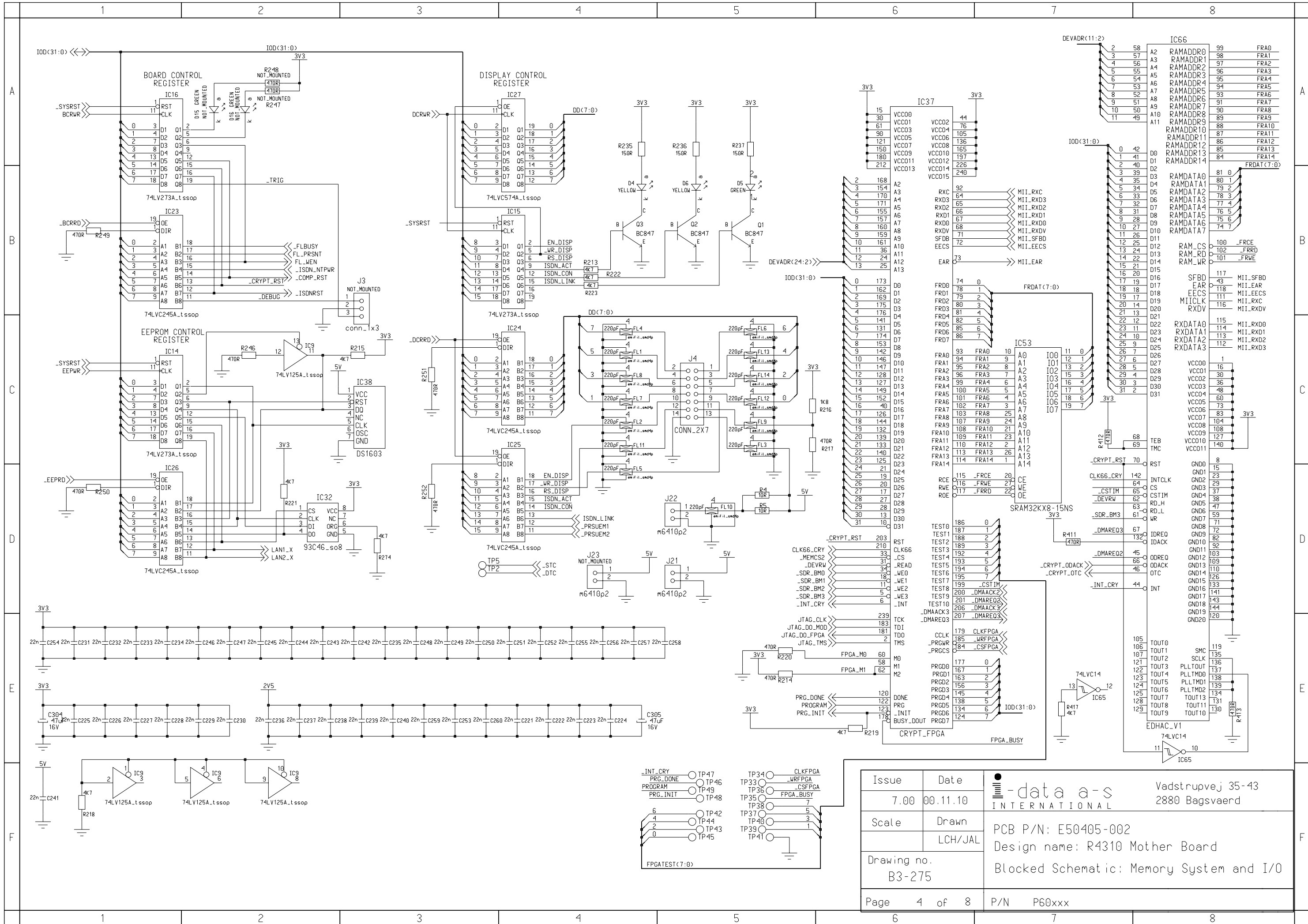

Issue	Date	-data a-s INTERNATIONAL	Vadstrupvej 35-43 2880 Bagsvaerd
7.00	00.11.10		
Scale	Drawn	PCB P/N: E50405-002	
	LCH/JAL	Design name: R4310 Mother Board	
Drawing no.	B3-275	Blocked Schematic: Memory System and I/O	
Page	4 of 8	P/N P60xxx	

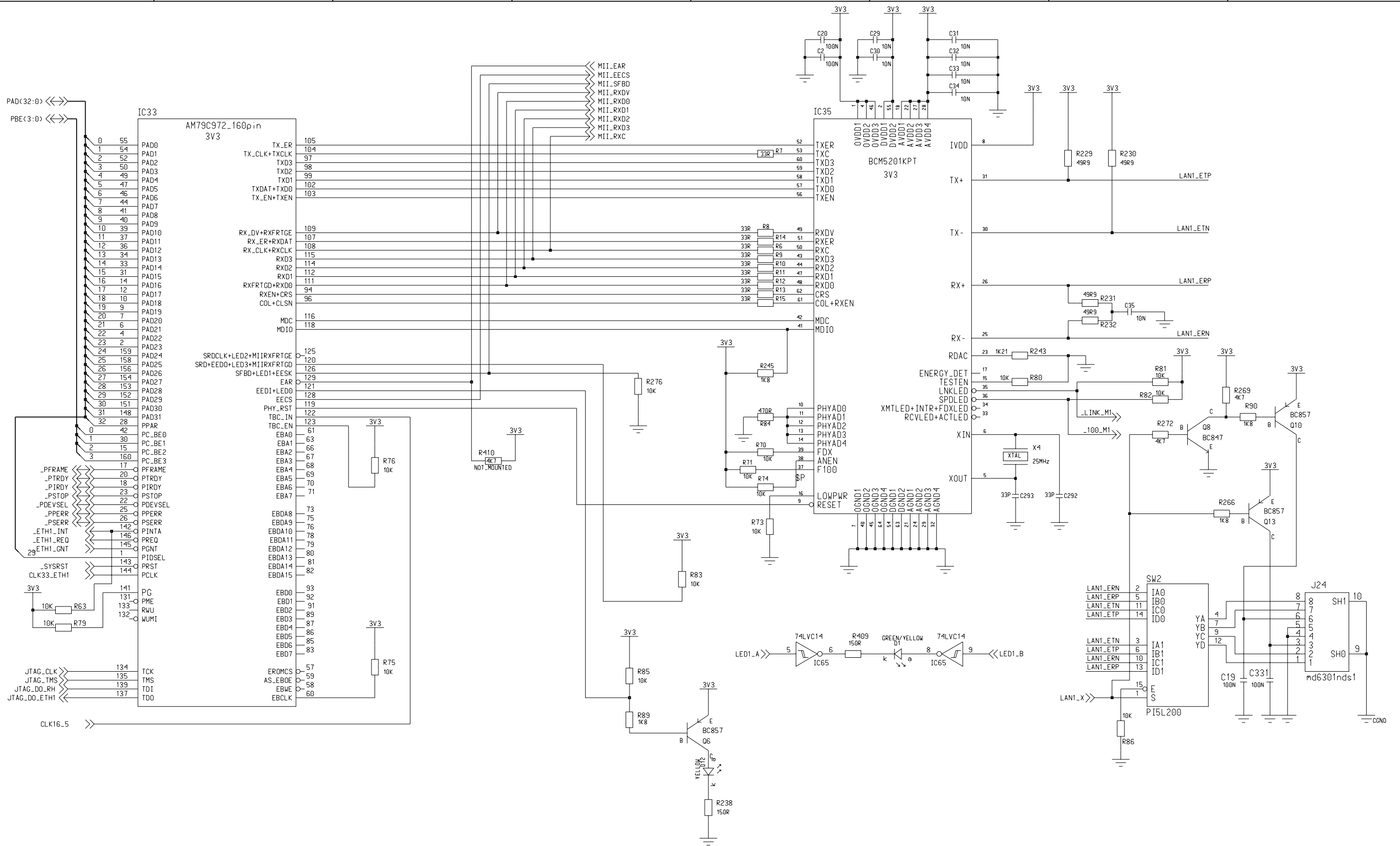

Issue	Date	-data a-s INTERNATIONAL	Vadstrupvej 35-43 2880 Bagsvaerd
7.00	00.11.11		
Scale	Drawn	PCB P/N: E50405-002	
	LCH/JAL	Design name: R4310 Mother Board	
Drawing no.		Blocked Schematic: Ethernet Interface 1	
B3-275			
Page	5 of 8	P/N	P60xxx

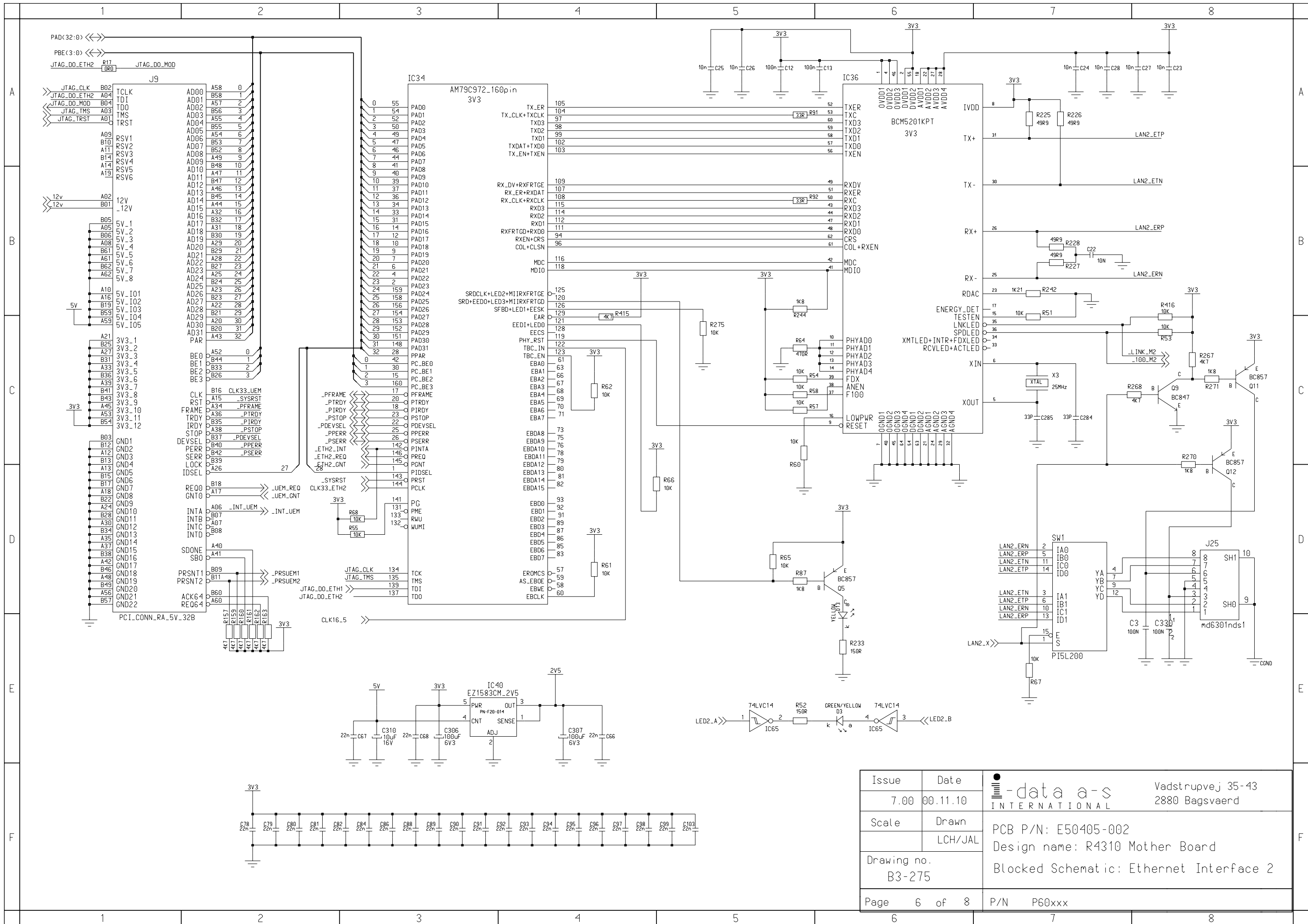

Issue	Date	-data a-s INTERNATIONAL	Vadstrupvej 35-43 2880 Bagsvaerd
7.00	00.11.10		
Scale	Drawn	PCB P/N: E50405-002	
	LCH/JAL	Design name: R4310 Mother Board	
Drawing no.	B3-275	Blocked Schematic: Ethernet Interface 2	
Page	6 of 8	P/N	P60xxx

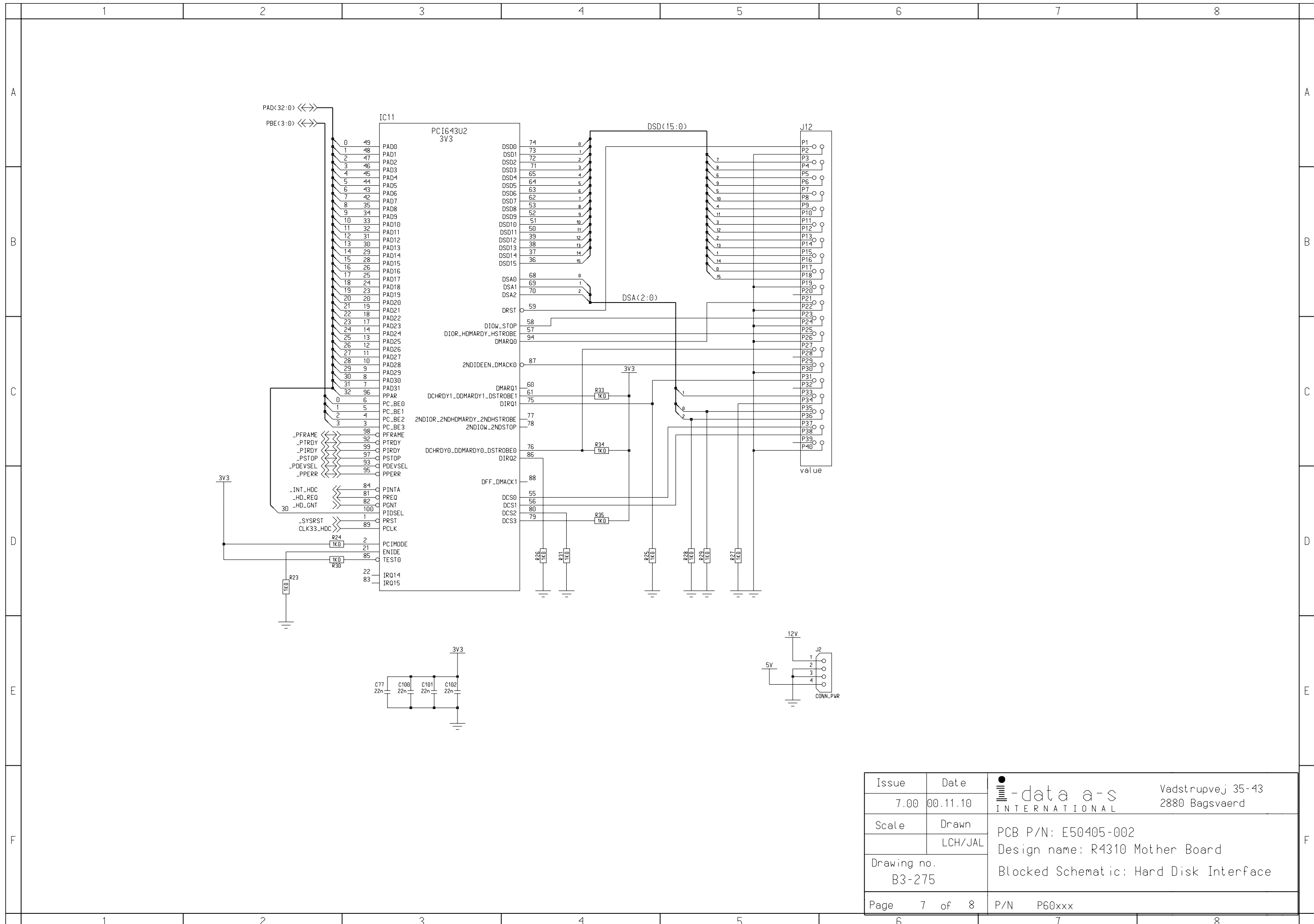

Issue	Date	 Vadstrupvej 35-43 2880 Bagsvaerd
7.00	00.11.10	
Scale	Drawn	PCB P/N: E50405-002 Design name: R4310 Mother Board Blocked Schematic: Hard Disk Interface
	LCH/JAL	
Drawing no. B3-275		
Page	7 of 8	P/N P60xxx

